

BUZZ

MINI BUZZ4

ON-GROUND

 **Unilamp**

LAST UPDATE: 09-08-2024



BUZZ is a robust ground mounted luminaire with excellent light control with three different types of light distribution. BUZZ has a wide beam light throw from a low mounting height which makes it a perfect fixture for illuminating the ground surface. It provides brilliant lighting quality with no glare from the above viewing angle. It is available in two sizes and operated with COB LED or HID light source. With the strong LM6 aluminium construction and clear polycarbonate cover, it protects the luminaire from dust and water and possible harmful impact. BUZZ is generally installed in the walkways and pathways in both private and public areas to provide visual guidance in the architectural environment. Anchorage unit for concrete foundation is available as an accessory.

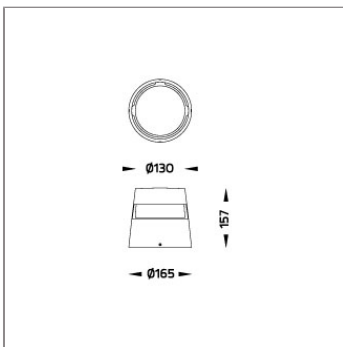

Technical Data



Ordering Code :	7167-O-3-901-XX
Lamp :	LED
CCT :	3000 K
CRI :	CRI >80
SDCM :	SDCM = 3
Lamp Lumen :	1850 lm
Luminaire Lumen :	530 lm
Lamp Wattage :	12 W
Luminaire Wattage :	16.0 W
Efficacy :	33 lm/W
Ambient Temperature :	50°C
Lumen Maintenance	L70B10 >60,000 h
Controller :	On-Off
Input Voltage :	220-240Vac 50/60Hz
Net Weight :	- kg.

Ordering code guide

XXXX-X-X-XXX-XX
A B C D E



















- A Product Code
- B Reflector
- C Electrical Component
- D Lamp
- E Color



Icon definition

*Due to the constancy of product development, we reserve the right to alter all specification without prior notice.

Specification

IEC Standard	IEC 60598-1 General Requirement IEC 60598-2-1 Fixed Luminaires												
Protection	IP66 Class I												
IK Rating	Protection against mechanical impact IK08 on body and IK07 optical part.												
Luminaires Body Housing	High-pressure die cast aluminum alloy body and components.												
Coating Process	Nano Ceramic surface conversion, resistant to corrosive environment. Luminaire primarily coated with epoxy resin and top coated with UV stabilized polyester powder and cured in digital temperature controlled chamber at 200°C.												
Diffuser	Self-extinguishing high impact resistant clear polycarbonate diffuser with UV stabilized additive.												
Reflector	High performance anodized spun aluminum reflector.												
Gasket	Post-cured treated silicone gasket. Temperature and weather resistant. Working temperature -40°C to +200°C.												
External Screws	External screws are in stainless steel with protection grease.												
Cable Entry	Cable entry protected by M20 cable gland. To be used with H05RN-F/ H07RN-F cable with 7-13mm. diameter.												
Led	High efficiency LED module in COB technology. Assembled on MCPCB and mounted on to heat conductive material.												
Driver	High quality constant current LED driver. Conform to safety standard and electromagnetic compatibility standard.												
Internal Wire	Tinned copper conductor with silicone insulated internal wire. IMQ approved. Working temperature -40°C to +180°C.												
Terminal Block	Terminal block in GFR PA6.6 for cable with cross section up to 2.5 sqmm. VDE approved. Class1 luminaire provided with the earth connection.												
Pre-Wire Cable	Pre-wired with 3x1.0 sqmm. H07RN-F neoprene cable. IMQ approved.												
Caution	Installation work has to be carried on according to the enclosed installation manual.												
Color	<table border="0"> <tr><td></td><td>Black O1</td></tr> <tr><td></td><td>Graphite O2</td></tr> <tr><td></td><td>Dark Grey O3</td></tr> <tr><td></td><td>Aluminum Silver O4</td></tr> <tr><td></td><td>White O6</td></tr> <tr><td></td><td>Wooden Brown O7</td></tr> </table>		Black O1		Graphite O2		Dark Grey O3		Aluminum Silver O4		White O6		Wooden Brown O7
	Black O1												
	Graphite O2												
	Dark Grey O3												
	Aluminum Silver O4												
	White O6												
	Wooden Brown O7												

Light Distribution

