

# SE7EN

SE7EN

BOLLARD

 **Unilamp**

LAST UPDATE: 13-09-2024



SE7EN, the angular designed bollard installed with high quality LED and manufactured from corrosion resistant extruded aluminium. SE7EN is an architectural piece in itself either on or off. No visible screws, no light spill, pre wired cable with IP68 connection and IP66 lamp compartment SE7EN fulfill all the needs for modern urban scenery. Available in 2700K, 3000K and 4000K in high CRI with exceptional color consistency. SE7EN is a perfect match for contemporary surrounding and can be installed in walkways, parks, commercial areas and open spaces.

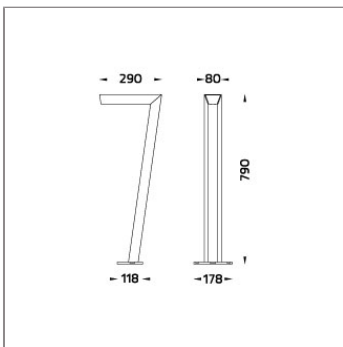

## Technical Data



Ordering Code :	7170-0-3-575-XX
Lamp :	LED
CCT :	3000 K
CRI :	CRI >80
SDCM :	SDCM = 3
Lamp Lumen :	1030 lm
Luminaire Lumen :	700 lm
Lamp Wattage :	7.7 W
Luminaire Wattage :	10 W
Efficacy :	70 lm/W
Ambient Temperature :	50°C
Lumen Maintenance	L80B10 >60,000 h
Controller :	On-Off
Input Voltage :	220-240Vac 50/60Hz
Net Weight :	2.30 kg.

### Ordering code guide

XXXX-X-X-XXX-XX

A B C D E

- A Product Code
- B Reflector
- C Electrical Component
- D Lamp
- E Color



Icon definition

\*Due to the constancy of product development, we reserve the right to alter all specification without prior notice.

# SE7EN



















## SE7EN

### BOLLARD



LAST UPDATE: 13-09-2024

## Specification

IEC Standard	IEC 60598-1 General Requirement IEC 60598-2-1 Fixed Luminaires												
Protection	IP66 Class II												
IK Rating	Protection against mechanical impact IK10 on body and IK07 on optical part.												
Luminaires Body Housing	High-pressure die cast aluminum alloy body and components. Extruded aluminum 56063 alloy body with low copper content.												
Coating Process	Nano ceramic surface conversion, resistant to corrosive environment. Luminaire primarily coated with epoxy resin and top coated with UV stabilized polyester powder and cured in digital temperature controlled chamber at 200°C.												
Diffuser	Impact resistant safety tempered glass cover. Able to withstand the temperature up to 250°C.												
Gasket	Weather resistant silicone gasket. Working temperature -40°C to +200°C.												
External Screws	External screws are in stainless steel with protection grease.												
Cable Entry	Cable entry protected by weather proof grommet. To be used with HO5RN-F/ HO7RN-F cable with 6-13mm. diameter.												
Led	High efficiency LED module utilized chips from world renowned manufacturer. Assembled on MCPCB and mounted on to heat conductive material.												
Driver	High quality constant current LED driver. Conform to safety standard and electromagnetic compatibility standard.												
Internal Wire	Tinned copper conductor with silicone insulated internal wire. IMQ approved. Working temperature -40°C to +180°C.												
Pre-Wire Cable	Pre-wired with 2x1.0 sqmm. HO7RN-F neoprene cable. IMQ approved. Main connection provided with IP68 watertight connecting device for cable diameter 7-12mm with 2.5 sqmm section.												
Caution	Installation work has to be carried on according to the enclosed installation manual.												
Color	<table><tr><td></td><td>Black O1</td></tr><tr><td></td><td>Graphite O2</td></tr><tr><td></td><td>Dark Grey O3</td></tr><tr><td></td><td>Aluminum Silver O4</td></tr><tr><td></td><td>White O6</td></tr><tr><td></td><td>Wooden Brown O7</td></tr></table>		Black O1		Graphite O2		Dark Grey O3		Aluminum Silver O4		White O6		Wooden Brown O7
	Black O1												
	Graphite O2												
	Dark Grey O3												
	Aluminum Silver O4												
	White O6												
	Wooden Brown O7												

## Light Distribution

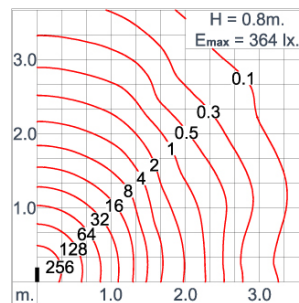
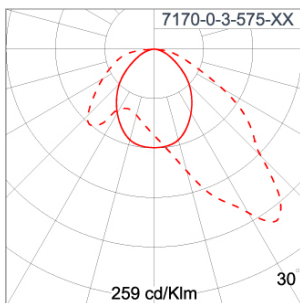

\*Due to the constancy of product development, we reserve the right to alter all specification without prior notice.

# SE7EN

SE7EN

BOLLARD



LAST UPDATE: 13-09-2024

## Bug Report

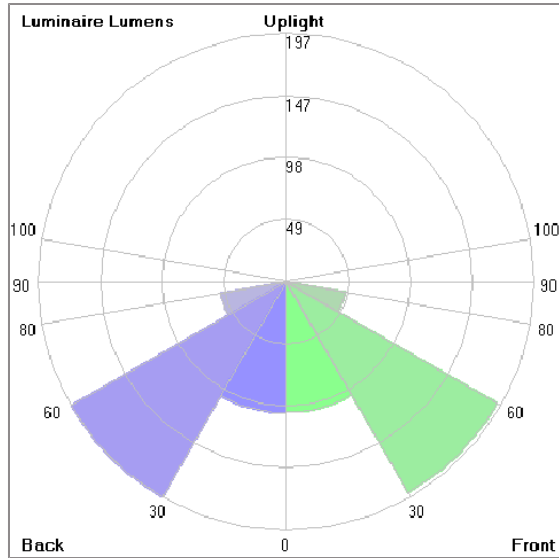

### Lum. Classification System [LCS]

LCS	Zone	%Lumens	%Lamp	%Lum
FL	[0-30]	103.5	10.1	14.8
FM	[30-60]	192.7	18.7	27.5
FH	[60-80]	47.5	4.6	6.8
FVH	[80-90]	1.2	0.1	0.2
BL	[0-30]	104.0	10.1	14.9
BM	[30-60]	196.6	19.1	28.1
BH	[60-80]	52.7	5.1	7.5
BVH	[80-90]	1.5	0.1	0.2
UL	[90-100]	< 0.05	0.0	0.0
UH	[100-180]	0.0	0.0	0.0
Total		699.7	67.9	100.0
BUG Rating		BO-U1-G0		

\*Due to the constancy of product development, we reserve the right to alter all specification without prior notice.

# SE7EN

SE7EN

BOLLARD

 **Unilamp**

LAST UPDATE: 13-09-2024

## Accessories



Ordering Code:

AUN-CON-0013-00

IP68 connection device,  
cable diameter 7-11.5mm,  
On-Off

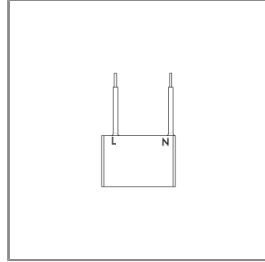

Ordering Code:

AUN-SUR-0004-00

Surge protection, 10kV,  
On-Off, pre-assembly from  
factory