

RGBW/RGB/CCT/Dimming 4 Channel LED RF Controller

Features

- 4 channel PWM constant voltage output, Max 8A per channel.
- Match with RF 2.4G single zone or multiple zone single color, dual color and RGB/RGBW remote control.
- One RF controller accept up to 10 remote control.
- 4096 levels 0-100% dimming smoothly without any flash.
- When using with RGB/RGBW light, built in 10 dynamic mode, include jump or gradual change style.
- Auto-transmitting function: Controller automatically transmit signal to another controller with 15m control distance.
- Synchronize on multiple number of controllers.
- Fade in and out effect selectable.
- PWM frequency 1KHz, 2KHz, 4KHz or 8KHz selectable.
- Over-load / Short circuit protection, recover automatically.



CE RoHS

Technical Parameters

Input and Output		Dimming data		Safety and EMC	
Input voltage	12-48VDC	Input signal	RF 2.4GHz	EMC standard	EN IEC 55015/ EN IEC 61547 ETSI EN 301 489-1/-3
Input current	32.5A@12/24V 20.5A@36/48V	Control distance	15m(Barrier-free space)	Safety standard	EN 61347-1/-2
Output voltage	4 x {12-48}VDC	Dimming gray scale	4096 (2^12) levels	Radio equipment	ETSI EN 300 440
Output current	4x8A@12/24V 4x5A@36/48V	Dimming curve	Logarithmic	Certification	CE RoHS
Output power	4x96W@12V 4x192W@24V 4x180W@36V 4x240W@48V	PWM frequency	1000Hz (default)	Environment	
Output type	Constant voltage	Package		Operation temperature	Ta: -30°C ~ +55°C
		Size	L120 x W80 x H30mm	Case temperature(Max.)	Tc: +85°C
		Gross weight	0.304kg	IP rating	IP20

Mechanical Structures and Installations

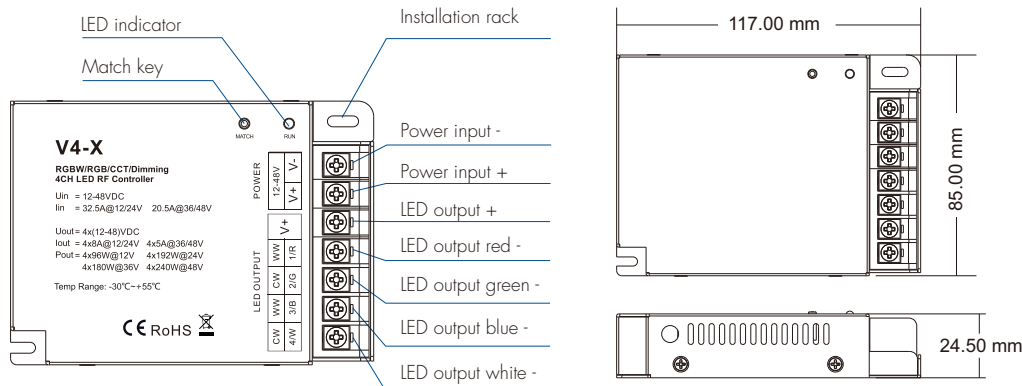

Match Remote Control (Two Match Ways)

End user can choose the suitable match/delete ways. Two options are offered for selection:

Use the controller's Match key

Match:
Short press match key, immediately press on/off key (single zone remote) or zone key (multiple zone remote) on the remote. The LED indicator fast flash a few times means match is successful.

Delete:
Press and hold match key for 5s to delete all match, The LED indicator fast flash a few times means all matched remotes were deleted.

Use Power Restart

Match:
Switch off the power, then switch on power, repeat again. Immediately short press on/off key (single zone remote) or zone key (multiple zone remote) 3 times on the remote. The light blinks 3 times means match is successful.

Delete:
Switch off the power, then switch on power, repeat again. Immediately short press on/off key (single zone remote) or zone key (multiple zone remote) 5 times on the remote. The light blinks 5 times means all matched remotes were deleted.

Wiring Diagram

• V4-X for RGB/RGBW

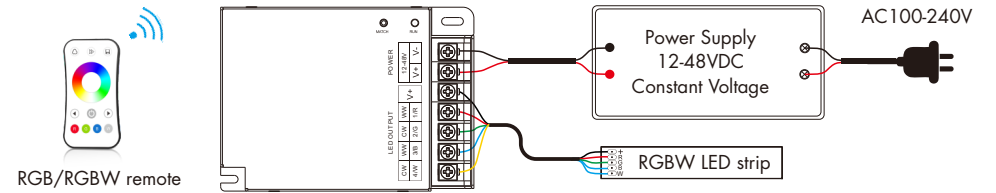

Note: If connect with RGB LED strip, please long press match key for 1.5s, the controller will become RGB type.

• V4-X for dual color

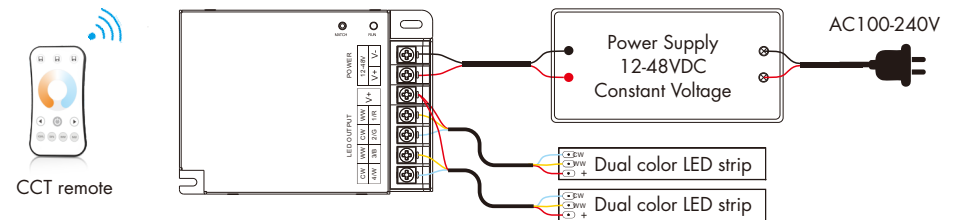

• V4-X for single color

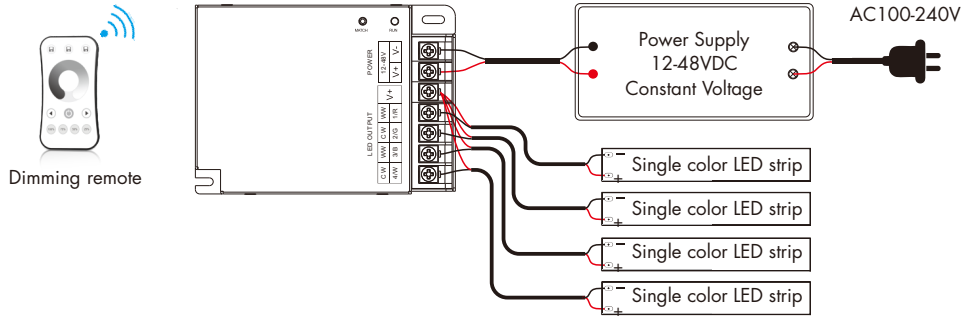

Wire Preparation:

1. The wiring can be solid or stranded with a cross-sectional area of 0.5 to 2.5 mm². Conventional 1mm² can withstand 10A output current.
2. When wiring is installed, the terminals must be tightened. If they are not tightened, the contact point resistance will be too high and the terminals will easily burn due to heat when used at full load for a long time.

Note: The output power of a constant voltage power supply should be at least 1.2 times that of the output load (light strip), otherwise the full power output of the load can easily cause automatic flickering or shaking of the light.

PWM Frequency Setting

At the moment of power-up:

- Long press the match key for 2s, set the output PWM frequency to 1KHz, the LED indicator flash 1 time.
 - Long press the match Key for 5s, set the output PWM frequency to 2KHz, the LED indicator flash 2 times.
 - Long press the match Key for 10s, set the output PWM frequency to 4KHz, the LED indicator flash 3 times.
 - Long press the match Key for 15s, set the output PWM frequency to 8KHz, the LED indicator flash 4 times.
- The factory default PWM frequency is 1KHz.

Note: Higher PWM frequency, will cause lower output current, higher power noise, but more suitable for camera(No flickers for video).

PWM frequency and output current mapping:

U _{in} \ U _{out} PWM	1KHz	2KHz	4KHz	8KHz
12/24V	8A	8A	5A	5A
36/48V	5A	5A	5A	3A

Light On/Off Fade Time

- Long press match key 5s, then short press match key 3 times, the light on/off time will be set to 3s, the indicator light blink 3 times.
- Long press match key 10s, restore factory default parameter, the light on/off time also restore to 0.5s.

Dual Color Control

CH1,CH3=Warm white LED CH2,CH4=Cool white LED

Each channel can supply up to 192W(@24V) and white balance can be controlled as such:

Color temperature	Cool white	Neutral white	Warm white
Power distribution	CH1=0W,CH2=192W CH3=0W,CH4=192W	CH1=96W,CH2=96W CH3=96W,CH4=96W	CH1=192W,CH2=0W CH3=192W,CH4=0W

Linear dual color tuning

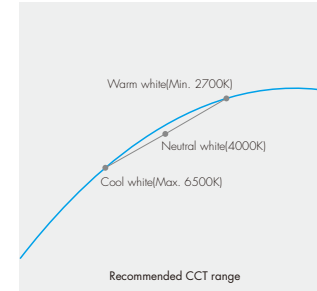

Dimming curve for CCT

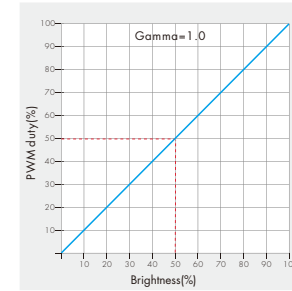

Dimming curve for RGBW/RGB/DIM

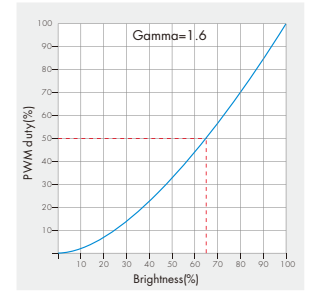

RGB/RGBW Dynamic Mode List

No.	Name	No.	Name
1	RGB jump	6	RGB fade in and out
2	RGB smooth	7	Red fade in and out
3	6 color jump	8	Green fade in and out
4	6 color smooth	9	Blue fade in and out
5	Yellow cyan purple smooth	10	White fade in and out

Installation Precautions

1. The products shall not be stacked, the distance should be ≥ 20cm, so as not to affect lifespan of the products due to poor heat dissipation.
2. The product shall not be installed close to the switching power supply with an interval of ≥ 20cm to avoid radiation interference of the switching power supply.
3. The installation height shall be ≥ 1m from the floor to avoid shortening the remote control distance due to too weak reception signal.
4. The products are not allowed to be close to or covered by metal objects, with an interval of ≥ 20cm to avoid signal attenuation and shorten the remote distance.
5. Avoid installation at the corner of the wall or the corner of the beam, with an interval of ≥ 20cm to avoid signal interference.